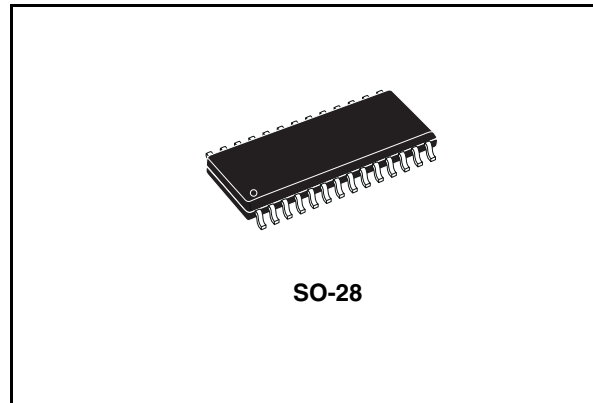

Smartcard interface**General features**

- 3V or 5V supply for the IC
- Step-up converter for V_{CC} generation
- 3 specific protected half duplex bi-directional buffered I/O lines
- Automatic activation and deactivation sequences
- Thermal and short-circuit protections on all card contacts
- 26MHz integrated crystal oscillator
- Clock generation for the card up to 20MHz with synchronous frequency changes
- ISO7816-3 compatible
- Enhanced ESD protection on card side
- SO-28 package
- Under voltage lockout protection selectable to 3V or 2.2V
- Supply supervisor integrated

**Description**

The ST8004 is a complete low cost analog interface for asynchronous 3V and 5V smart cards. It can be placed between the card and the microcontroller with few external components to perform all supply protection and control functions. Main applications are: smartcard readers for Set Top Box, IC card readers for banking, identification.

Order code

Part number	Temperature range	Package	Packaging
ST8004CDR	0 to 85 °C	SO-28 (Tape & Reel)	1000 parts per reel

Contents

- 1 Diagram 3**
- 2 Pin configuration 4**
- 3 Maximum ratings 6**
- 4 Electrical characteristics 7**
- 5 Waveforms 12**
- 6 Functional description 15**
 - 6.1 Power supply 15
 - 6.2 Voltage supervisor (for VTHSEL = VDD or floating) 15
 - 6.3 Voltage supervisor (for VTHSEL = GND) 15
 - 6.4 Clock circuitry 16
 - 6.5 I/O Circuitry 16
 - 6.6 Inactive state 17
 - 6.7 Activation sequence 17
 - 6.8 Active state 17
 - 6.9 Deactivation sequence 18
 - 6.10 Fault detection 18
- 7 Package mechanical data 22**
- 8 Revision history 25**

1 Diagram

Figure 1. Block diagram

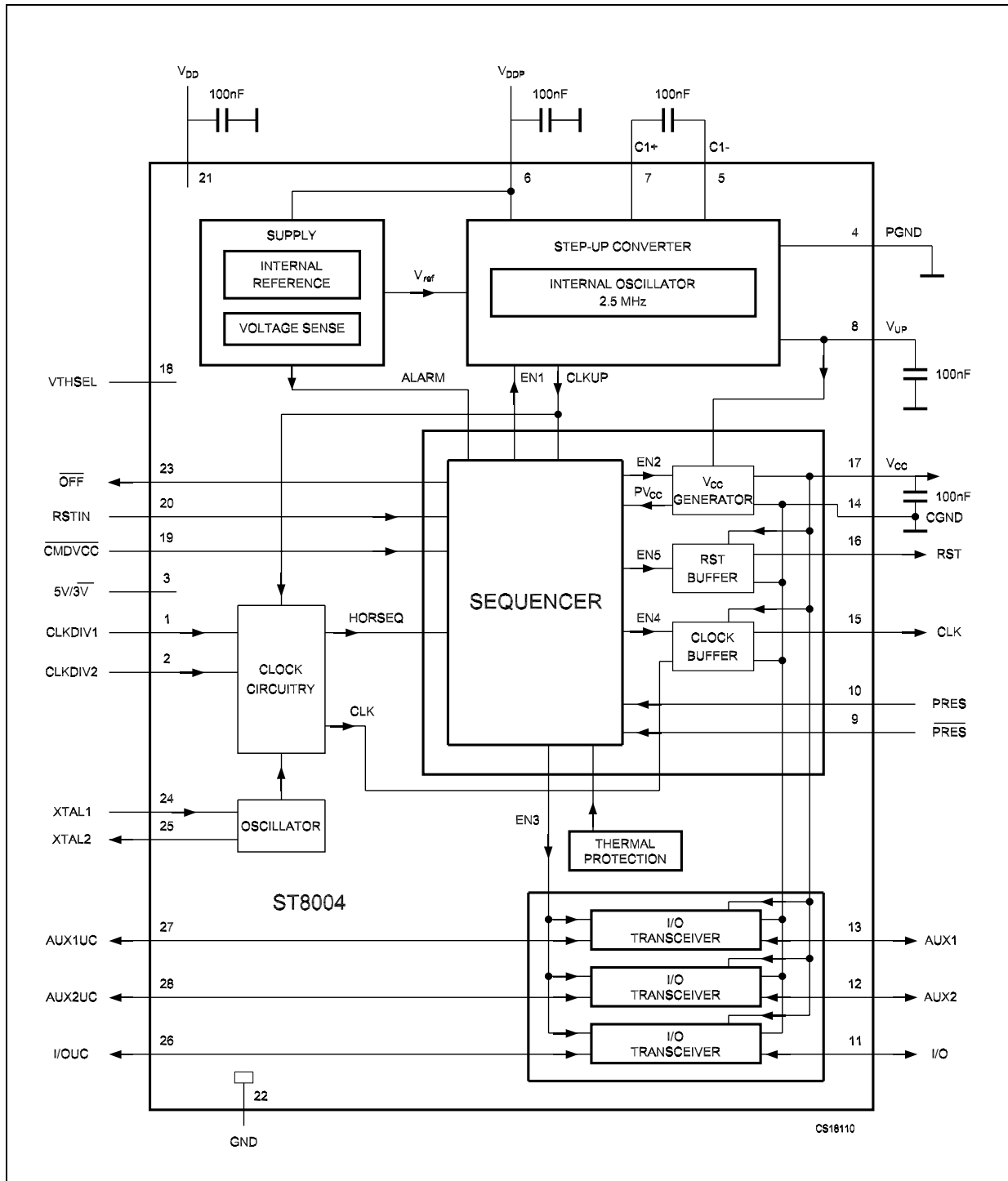

2 Pin configuration

Figure 2. Pin connections

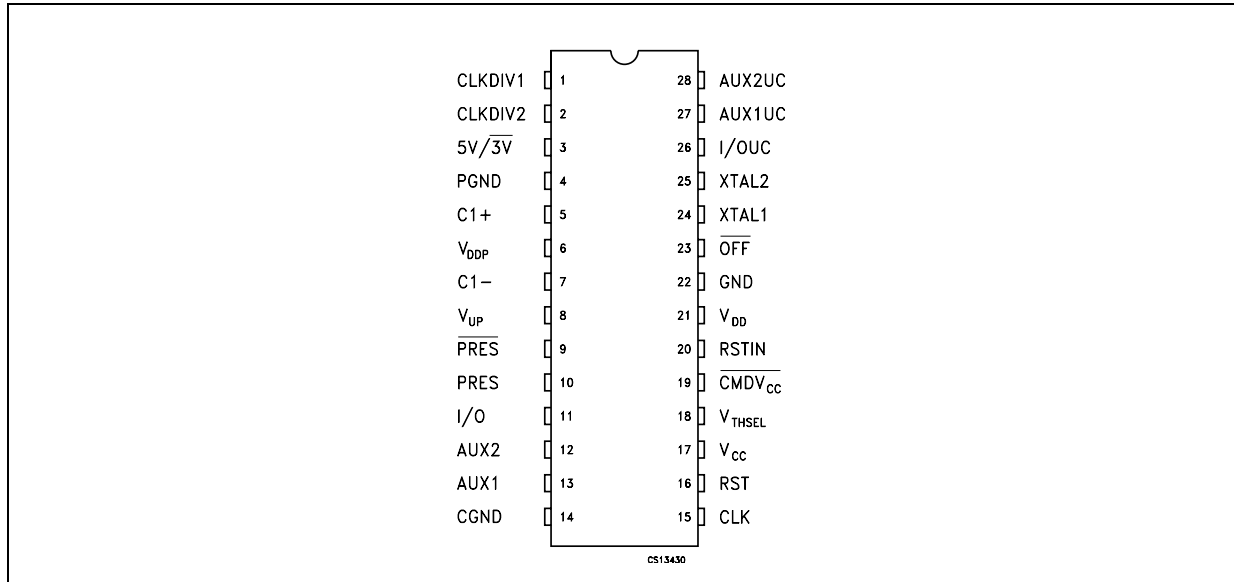

Table 1. Pin description

Pin N°	Symbol	Name and function
1	CLKDIV1	Control of CLK Frequency
2	CLKDIV2	Control of CLK Frequency
3	5V/3V	V _{CC} selection pin.
4	PGND	Power Ground for Step-Up converter
5	C1+	External Cap. for Step-Up converter
6	V _{DDP}	Power Supply for Step-Up converter
7	C1-	External Cap. Step-Up converter
8	V _{UP}	Output of Step-Up converter
9	PRES	Card Presence Input (Active Low)
10	PRES	Card Presence Input (Active High)
11	I/O	Data Line to and from card (C7) (internal 10kΩ pull-up resistor connected to V _{CC})
12	AUX2	Auxiliary line to and from card (C8) (internal 10kΩ pull-up resistor connected to V _{CC})
13	AUX1	Auxiliary line to and from card (C4) (internal 10kΩ pull-up resistor connected to V _{CC})
14	CGND	Ground for card signal (C5)
15	CLK	Clock to card (C3)
16	RST	Card Reset (C2)
17	V _{CC}	Supply Voltage for the card (C1)
18	V _{THSEL}	Deactivation threshold selector pin (under voltage lock-out)
19	CMDV _{CC}	Start activation sequence input (Active Low)

Table 1. Pin description

Pin N°	Symbol	Name and function
20	RSTIN	Card Reset Input from MCU
21	V _{DD}	Supply Voltage
22	GND	Ground
23	OFF	Interrupt to MCU (active Low)
24	XTAL1	Crystal or external clock input
25	XTAL2	Crystal connection (leave this pin open if external clock is used)
26	I/OUC	Data Line to and from MCU (internal 10kΩ pull-up resistor connected to V _{DD})
27	AUX1UC	Auxiliary line to and from MCU (internal 10kΩ pull-up resistor connected to V _{DD})
28	AUX2UC	Auxiliary line to and from MCU (internal 10kΩ pull-up resistor connected to V _{DD})

3 Maximum ratings

Table 2. Absolute maximum ratings

Symbol	Parameter	Min	Max	Unit
V_{DD}, V_{DDP}	Supply voltage	-0.3	7	V
V_{n1}	Voltage on pins XTAL1, XTAL2, $5V/\sqrt{3V}$, RSTIN, AUX2UC, AUX1UC, I/OUC, CLKDIV1, CLKDIV2, V_{THSEL} , \overline{CMDV}_{CC} , \overline{PRES} , PRES and \overline{OFF}	-0.3	$V_{DD} + 0.3$	V
V_{n2}	Voltage on card contact pins I/O, RST, AUX1, AUX2 and CLK	-0.3	$V_{CC} + 0.3$	V
V_{n3}	Voltage on pins V_{UP} S1 and S2		9	V
ESD1	MIL-STD-883 class 3 on card contact pins, \overline{PRES} and PRES (Note 1, 2)	-6	6	KV
ESD2	MIL-STD-883 class 2 on μC contact pins and RSTIN (Note 1, 2)	-2	2	KV

Note: Absolute Maximum Ratings are those values beyond which damage to the device may occur. Functional operation under these conditions is not implied.

- Note: 1 All card contacts are protected against any short with any other card contact.
 2 Method 3015 (HBM, 1500 Ω , 100 pF) 3 positive pulses and 3 negative pulses on each pin referenced to ground.

Table 3. Thermal data

Symbol	Parameter	Condition	Value	Unit
R_{thJA}	Thermal resistance junction-ambient temperature	In free air	70	$^{\circ}K/W$

Table 4. Recommended operating conditions

Symbol	Parameter	Test Conditions	Min.	Typ.	Max.	Unit
T_A	Temperature range		-25		85	$^{\circ}C$

4 Electrical characteristics

Table 5. Electrical characteristics over recommended operating ($V_{DD} = 3.3V$, $V_{DDP} = 5V$, $f_{XTAL} = 10MHz$, unless otherwise noted. Typical values are to $T_A = 25^{\circ}C$)

Symbol	Parameter	Test Conditions	Min.	Typ.	Max.	Unit
V_{DD}	Supply voltage	$V_{THSEL} = V_{DD}$ or floating	2.7		6.5	V
		$V_{THSEL} = GND$	3.150		6.5	
V_{DDP}	Supply voltage for the voltage doubler		4.5	5	6.5	V
		To comply with $V_{I(RIPPLE)(P-P)}$ specifications	4.75		5.25	
$V_{O(VUP)}$	Output voltage on pin V_{UP} from step-up converter			5.5		V
$V_{I(VUP)}$	Input voltage to be applied on V_{UP} in order to block the step-up converter		7		9	V
I_{DD}	Supply current	Inactive mode			1.2	mA
		Active mode; $f_{CLK} = f_{XTAL}$; $C_L = 30pF$			1.5	
I_P	Supply current for step-up converter	Inactive mode			0.1	mA
		Active mode; $f_{CLK} = f_{XTAL}$; $C_L = 30pF$	$I_{CC}=0$		18	
			$I_{CC}=65\text{ mA}$		150	
V_{th2}	Threshold voltage on V_{DD}	$V_{THSEL} = V_{DD}$ or floating	2.2		2.4	V
V_{th3}	Threshold voltage on V_{DD}	$V_{THSEL} = GND$	2.9		3.08	V
$V_{HYS(th2)}$	Hysteresis on V_{th2}	$V_{THSEL} = V_{DD}$ or floating	50		150	mV
$V_{HYS(th3)}$	Hysteresis on V_{th3}	$V_{THSEL} = GND$		0		mV
t_w	Pulse width of the internal alarm pulse		6		20	ms
ΔT_{HFIL}	Delay of internal filter	$V_{THSEL} = GND$	5		50	μs

Table 6. Card supply voltage characteristics ($V_{DD} = 3.3V$, $V_{DDP} = 5V$, $f_{XTAL} = 10MHz$, unless otherwise noted. Typical values are to $T_A = 25^\circ C$) (Note 1)

Symbol	Parameter	Test Conditions	Min.	Typ.	Max.	Unit	
V_{CC}	Output voltage including ripple	Inactive mode	-0.1		0.1	V	
		Inactive mode; $I_{CC} = 1\text{ mA}$	-0.1		0.4		
		Active Mode; $V_{DDP} = 5V \pm 5\%$ $ I_{CC} < 65\text{ mA DC}$	5 V card	4.75			5.25
			3 V card	2.85			3.15
		Active Mode; single current pulse of 100 mA; 2 μs	5 V card	4.65			5.25
			3 V card	2.85			3.15
Active Mode; current pulse of 40 nAs with $ I_{CC} < 200\text{mA}$ $t < 400\text{ ns}$	5 V card	4.65		5.25			
	3 V card	2.76		3.15			
$V_{I(RIPPLE)}$ (P-P)	Peak to peak ripple voltage on V_{CC}	20 KHz to 200 MHz, $V_{DDP} = 5V \pm 5\%$			350	mV	
$ I_{CC} $	Output current	From 0 to 5V or to 3V			65	mA	
		V_{CC} short circuit to GND			150		
S_R	Slew rate	Up to down	0.11		0.22	V/ μs	

Table 7. Crystal connection (pins XTAL1 and XTAL2) ($V_{DD} = 3.3V$, $V_{DDP} = 5V$, $f_{XTAL} = 10MHz$, unless otherwise noted. Typical values are to $T_A = 25^\circ C$)

Symbol	Parameter	Test Conditions	Min.	Typ.	Max.	Unit
C_{EXT}	External capacitors on pins XTAL1, XTAL2	Depending on specification of crystal or resonator used			15	pF
$f_{I(XTAL)}$	Crystal Input Frequency		2		26	MHz
$V_{IH(XTAL)}$	High level input voltage on XTAL1		$0.7 V_{DD}$		V_{DD}	V
$V_{IL(XTAL)}$	Low level input voltage on XTAL1		0		$0.3 V_{DD}$	V

Table 8. Data lines (pins I/O, AUX1, AUX2, AUX1UC and AUX2UC) ($V_{DD} = 3.3V$, $V_{DDP} = 5V$, $f_{XTAL} = 10MHz$, unless otherwise noted. Typical values are to $T_A = 25^\circ C$)

Symbol	Parameter	Test Conditions	Min.	Typ.	Max.	Unit
$t_{D(EDGE)}$	Delay between falling edge on pin I/O and I/OUC and width of active pull-up pulse			200		ns
$f_{I/O(MAX)}$	Maximum frequency of data lines				1	MHz
C_I	Input capacitance on data lines				10	pF

Table 9. Data lines (pins I/O, AUX1 AND AUX2 WITH 10 kΩ Pull-up resistor connected to V_{CC} Internally (V_{DD} = 3.3V, V_{DDP} = 5V, f_{X_{TAL}} = 10MHz, unless otherwise noted. Typical values are to T_A = 25°C)

Symbol	Parameter	Test Conditions	Min.	Typ.	Max.	Unit
V _{OH}	High level output voltage on data lines	I _{OH} = - 40μA	0.75 V _{CC}		V _{CC}	V
		No Load	0.9 V _{CC}		V _{CC} +0.3	
V _{OL}	Low level output voltage on data lines	I _{OL} = 1 mA			300	mV
V _{IH}	High level input voltage on data lines		1.8		V _{CC}	V
V _{IL}	Low level input voltage on data lines		-0.3		0.8	V
V _{INACTIVE}	Voltage on data lines when inactive	No Load			0.1	V
		I _{I/O} = 1 mA			0.3	
I _{EDGE}	Current from data lines when active pull-up is active	V _{OH} = 0.7 x V _{CC} ; C _O = 80 pF	-1			mA
I _{IH}	Input leakage current when high	V _{IH} = V _{CC}			10	μA
I _{IL}	Low level input current	V _{IL} = 0			600	μA
R _{PU(INT)}	Internal pull-up resistance to V _{CC}		9		13	KΩ
t _{T(DI)}	Input transition times	From V _{IL} max to V _{IH} min			1	μs
t _{T(DO)}	Output transition times	C _O = 80 pF, no DC load; 0.4 V to 70% from 0 to V _{CC}			0.1	μs
C _I	Input capacitance				10	pF

Table 10. Data lines (pins I/OUC, AUX1UC AND AUX2UC with 10 kΩ Pull-up resistor connected to V_{DD} internally (V_{DD} = 3.3V, V_{DDP} = 5V, f_{X_{TAL}} = 10MHz, unless otherwise noted. Typical values are to T_A = 25°C)

Symbol	Parameter	Test Conditions	Min.	Typ.	Max.	Unit
V _{OH}	High Level Output Voltage	I _{OH} = - 40μA	0.75 V _{DD}		V _{DD}	V
		No Load	0.9 V _{DD}			
V _{OL}	Low Level Output Voltage	I _{OL} = 1 mA	0		300	mV
V _{IH}	High Level Input Voltage		0.7 V _{DD}		V _{DD}	V
V _{IL}	Low Level Input Voltage		0		0.3 V _{DD}	V
I _{L IH}	Input Leakage Current when high	V _{IH} = V _{DD}			10	μA
I _{IL}	Input Leakage Current when low	V _{IL} = 0			600	μA
R _{PU(INT)}	Internal pull-up resistance to V _{DD}		9	11	13	KΩ

Table 10. Data lines (pins I/OUC, AUX1UC AND AUX2UC with 10 kΩ Pull-up resistor connected to V_{DD} internally) (V_{DD} = 3.3V, V_{DDP} = 5V, f_{XTAL} = 10MHz, unless otherwise noted. Typical values are to T_A = 25°C)

Symbol	Parameter	Test Conditions	Min.	Typ.	Max.	Unit
t _{T(DI)}	Input transition times	From V _{IL} max to V _{IH} min			1	μs
t _{T(DO)}	Output transition times	C _O = 30 pF, no DC load; 10% to 90% from 0 to V _{DD}			0.1	μs
C _I	Input capacitance				10	pF

Table 11. Internal oscillator (V_{DD} = 3.3V, V_{DDP} = 5V, f_{XTAL} = 10MHz, unless otherwise noted. Typical values are to T_A = 25°C)

Symbol	Parameter	Test Conditions	Min.	Typ.	Max.	Unit
f _{OSC(INT)}	Frequency of internal oscillator		2.2		3.2	MHz

Table 12. Reset output to the card (pin RST) (V_{DD} = 3.3V, V_{DDP} = 5V, f_{XTAL} = 10MHz, unless otherwise noted. Typical values are to T_A = 25°C)

Symbol	Parameter	Test Conditions	Min.	Typ.	Max.	Unit
V _{O(INACTIVE)}	Output Voltage in Inactive Mode	I _O = 1 mA	0		0.3	V
		No Load	0		0.1	
t _{D(RSTIN-RST)}	Delay between pins RSTIN and RST	RST Enable			2	μs
V _{OL}	Low Level Output Voltage	I _{OL} = 200 μA	0		0.2	V
V _{OH}	High Level Output Voltage	I _{OH} = -200 μA	0.9 V _{CC}		V _{CC}	V
t _R , t _F	Rise and fall time (10% to 90% of V _{CC})	C _O = 250 pF			0.1	μs

Table 13. Clock output to the card (pin CLK) (V_{DD} = 3.3V, V_{DDP} = 5V, f_{XTAL} = 10MHz, unless otherwise noted. Typical values are to T_A = 25°C)

Symbol	Parameter	Test Conditions	Min.	Typ.	Max.	Unit
V _{O(INACTIVE)}	Output Voltage in Inactive Mode	I _O = 1 mA	0		0.3	V
		No Load	0		0.1	
V _{OL}	Low Level Output Voltage	I _{OL} = 200 μA	0		0.3	V
V _{OH}	High Level Output Voltage	I _{OH} = -200 μA	0.9 V _{CC}		V _{CC}	V
t _R , t _F	Rise and fall time (10% to 90% of V _{CC})	C _O = 35 pF (Note 2)			8	ns
d	Duty cycle factor (except for f _{XTALS}) (See Note 4)	C _O = 35 pF (Note 2)	45		55	%
S _R	Slew Rate (rise and fall edge)	C _O = 35 pF	0.2			V/ns

Table 14. Logic inputs (pins CLKDIV1, CLKDIV2, PRES, \overline{PRES} , CMDV_{CC}, RSTIN and 5V/3V, VTHSEL (V_{DD} = 3.3V, V_{DDP} = 5V, f_{X_{TAL}} = 10MHz, unless otherwise noted. Typical values are to T_A = 25°C) (Note 3)

Symbol	Parameter	Test Conditions	Min.	Typ.	Max.	Unit
V _{IL}	Low Level Input Voltage		0		0.3 V _{DD}	V
V _{IH}	High Level Input Voltage		0.7 V _{DD}		V _{DD}	V
I _{L_{IH}}	Input Leakage Current when high	V _{IL} = 0 to V _{DD}			5	μA
I _{L_{IL}}	Input Leakage Current when low	V _{IH} = 0 to V _{DD}			5	μA

Table 15. \overline{OFF} outputs (pin \overline{OFF} is an open drain with an internal 20 kΩ Pull-up resistor to V_{DD}); (see note 5) (V_{DD} = 3.3V, V_{DDP} = 5V, f_{X_{TAL}} = 10MHz, unless otherwise noted. Typical values are to T_A = 25°C)

Symbol	Parameter	Test Conditions	Min.	Typ.	Max.	Unit
V _{OL}	Low Level Output Voltage	I _{OL} = 2 mA			0.4	V
V _{OH}	High Level Output Voltage	I _{OH} = -15 μA	0.75 V _{DD}			V

Table 16. Protection (V_{DD} = 3.3V, V_{DDP} = 5V, f_{X_{TAL}} = 10MHz, unless otherwise noted. Typical values are to T_A = 25°C)

Symbol	Parameter	Test Conditions	Min.	Typ.	Max.	Unit
T _{SD}	Shut down temperature			135		°C
I _{CC(SD)}	Shut down current at V _{CC}				150	mA

Table 17. Timing (V_{DD} = 3.3V, V_{DDP} = 5V, f_{X_{TAL}} = 10MHz, unless otherwise noted. Typical values are to T_A = 25°C)

Symbol	Parameter	Test Conditions	Min.	Typ.	Max.	Unit
t _{ACT}	Activation sequence duration	(See Figure 5.)		180	220	μs
t _{DE}	Deactivation sequence duration	(See Figure 6.)	60	80	100	μs
t ₃	Start of the windows to send CLK to card	(See Figure 5.)			130	μs
t ₅	End of the windows to send CLK to card	(See Figure 5.)	140			μs

Note: 1 To meet these specifications V_{CC} should be decoupled to CGND using two ceramic multiplier capacitors of low ESR with values of 100nF.

2 The transition time and duty cycle factor are shown in [Figure 9.](#); $d = t1/(t1+t2)$.

3 \overline{PRES} and CMDVCC are active Low; RSTIN and PRES are active High

4 Referred to the paragraph "CLOCK CIRCUITRY"

5 See paragraph "FAULT DETECTION".

5 Waveforms

Figure 3. Alarm as a function of V_{DD} ($t_W = 10$ ms), $V_{THSEL} = V_{DD}$ or floating

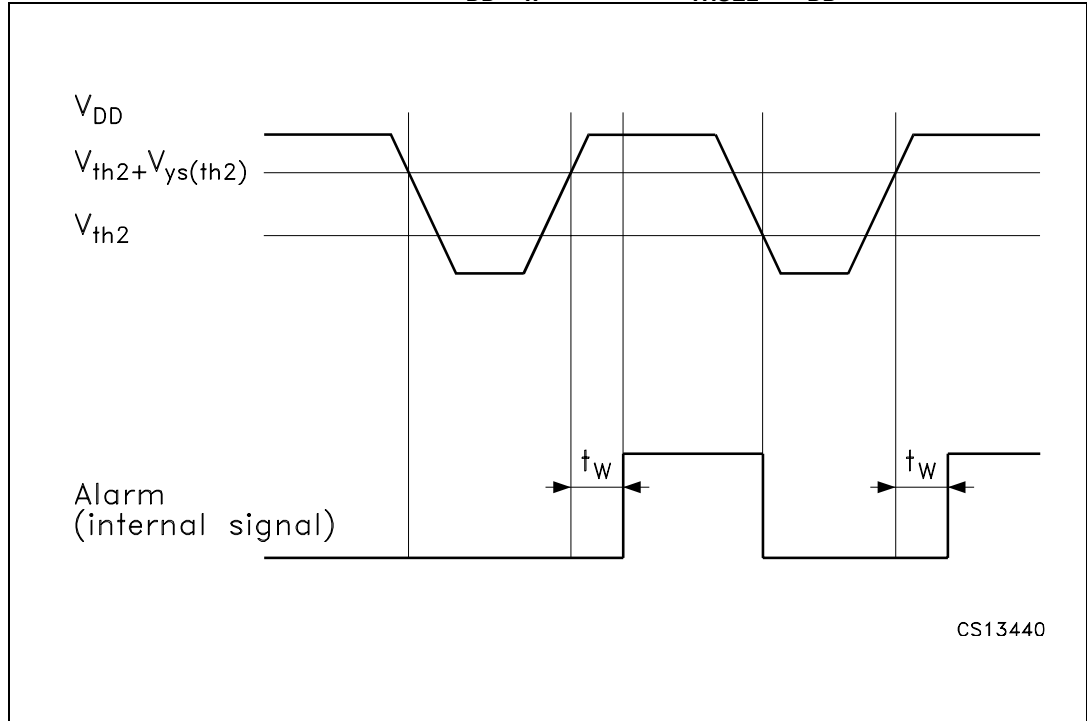

Figure 4. Alarm as a function of V_{DD} ($t_W = 10$ ms), $V_{THSEL} = GND$

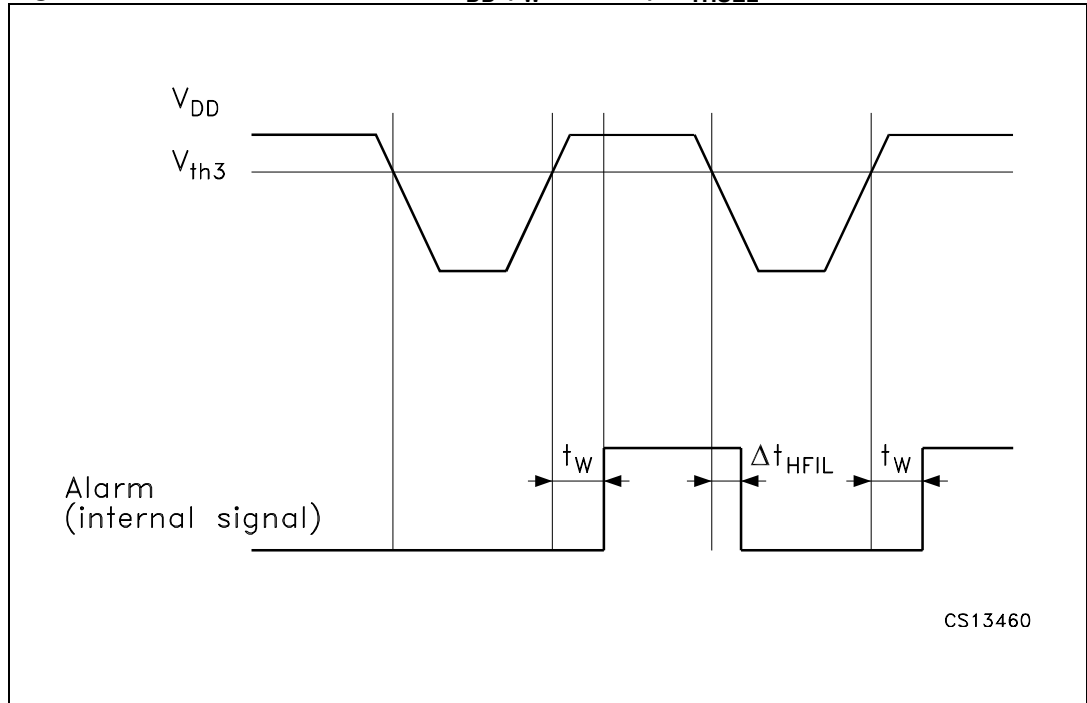

Figure 5. Activation sequence

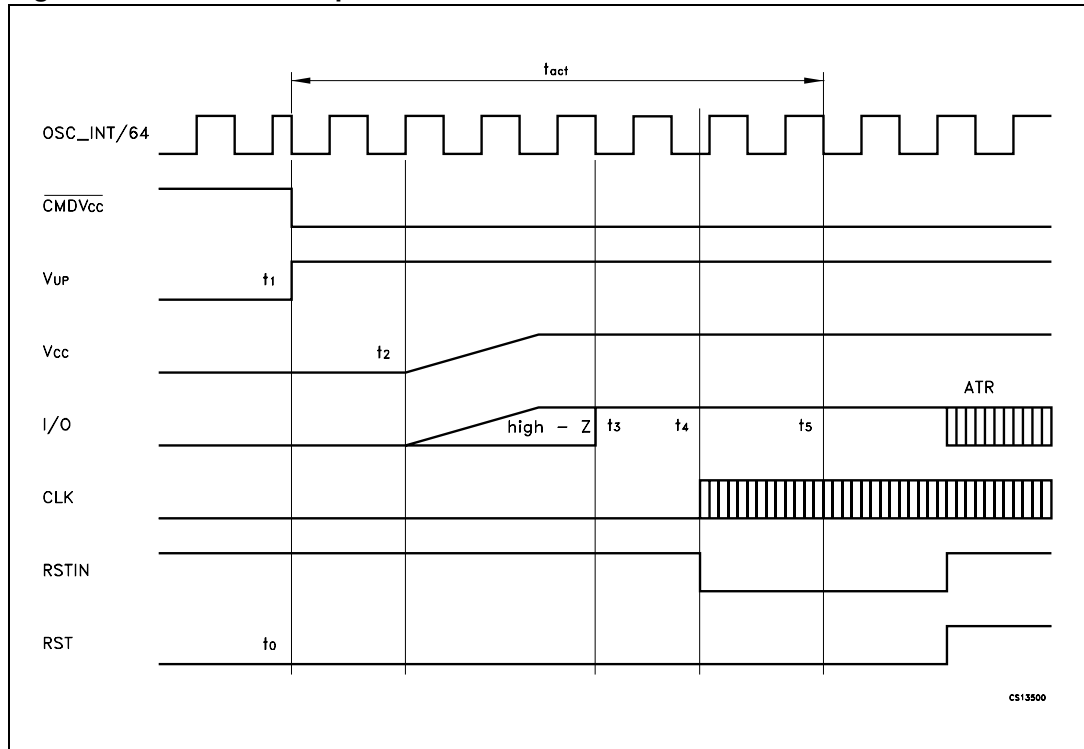

Figure 6. Deactivation sequence

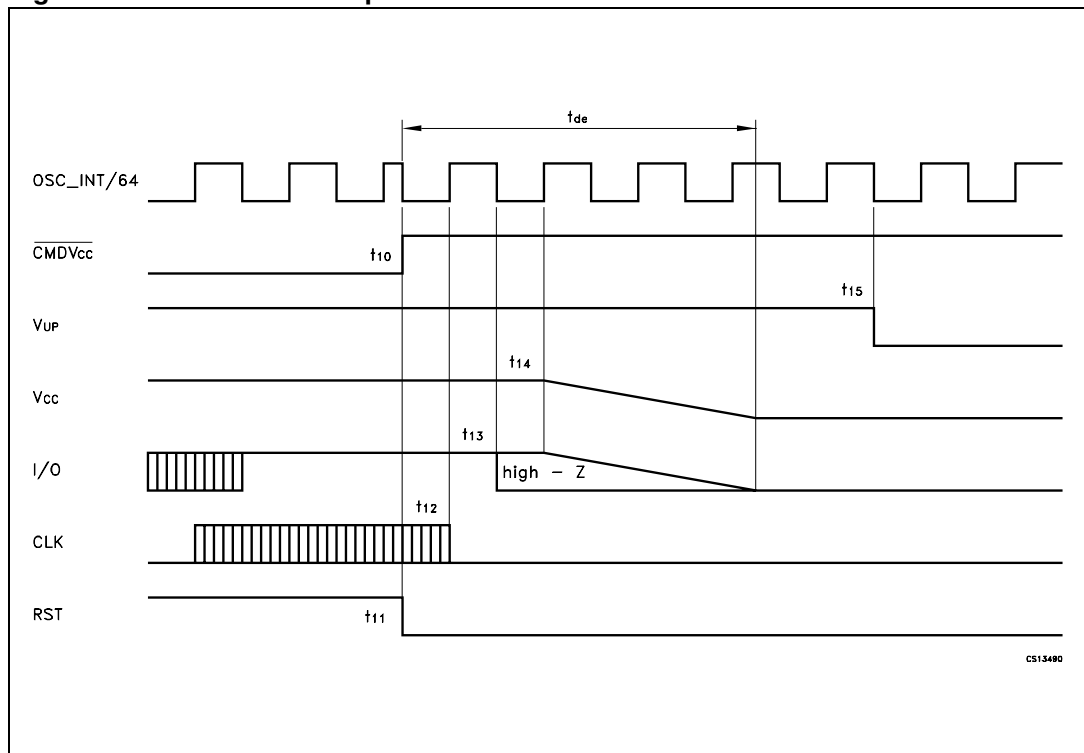
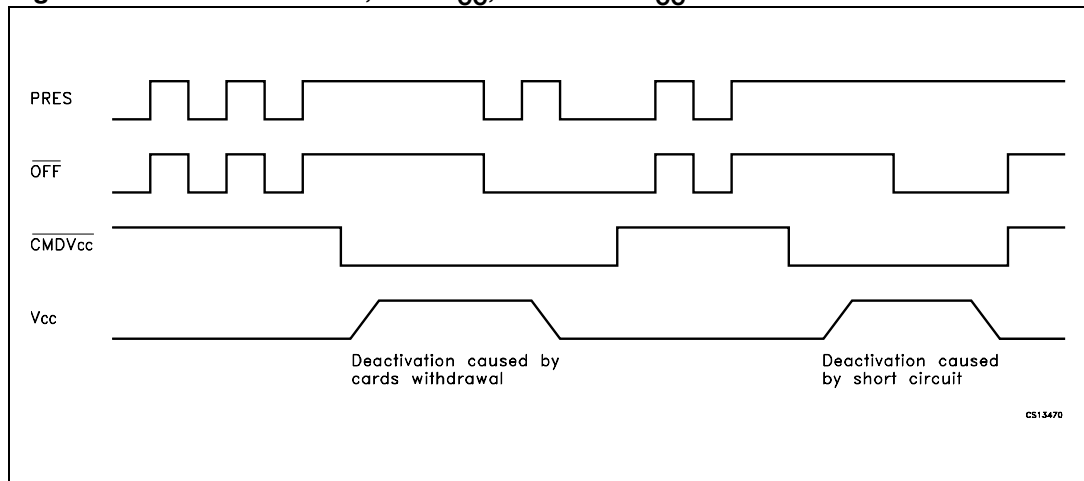
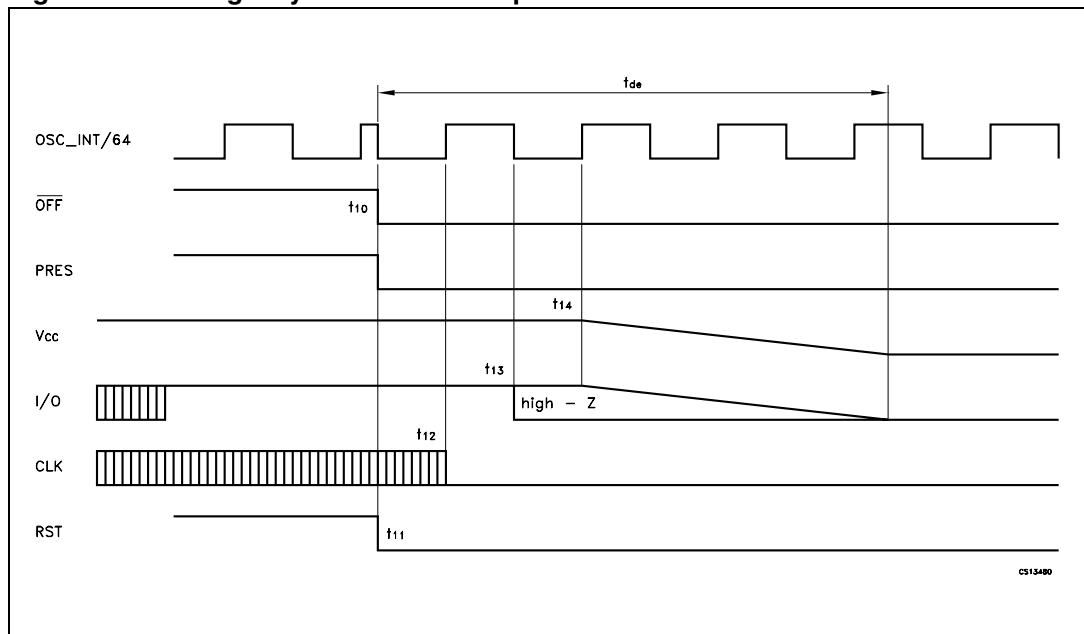

Figure 7. Behavior of $\overline{\text{OFF}}$, $\overline{\text{CMDV}}_{\text{CC}}$, PRES and V_{CC}



CS13470

Figure 8. Emergency deactivation sequence



CS13480

Figure 9. Definition of output transition times

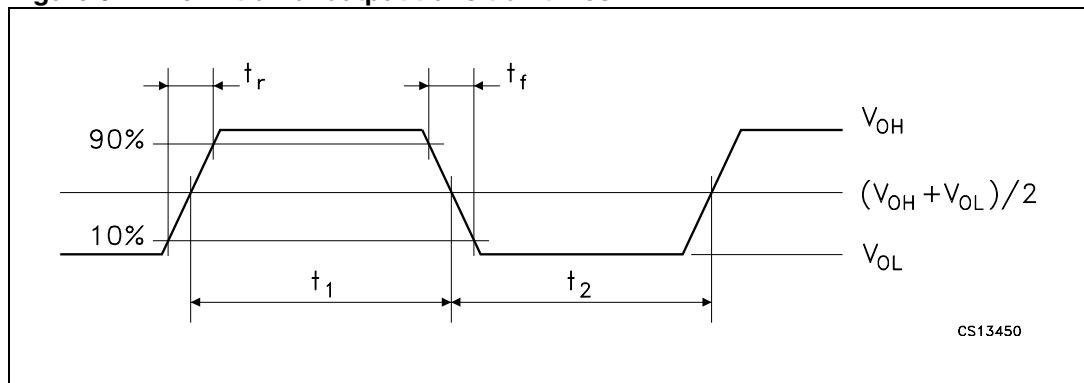

CS13450

6 Functional description

Throughout this document it is assumed that the reader is familiar with iso7816 norm terminology

6.1 Power supply

The supply pins for the IC are V_{DD} and GND. V_{DD} should be in the range of 2.7 to 6.5 V. All interface signals with the microcontroller are referenced to V_{DD} ; therefore be sure the supply voltage of the microcontroller is also at V_{DD} . All card contacts remain inactive during powering up or powering down. The sequencer is not activated until V_{DD} reaches $V_{th2} + V_{hys(th2)}$ or $V_{th3} + V_{hys(th3)}$ when $V_{THSEL} = GND$. When V_{DD} falls below V_{th2} or V_{th3} , an automatic deactivation of the contacts is performed. To generate a $5 V \pm 5\% V_{CC}$ supply to the card, an integrated voltage doubler is incorporated. This step-up converter should be separately supplied by V_{DDP} and PGND (from 4.5 to 6.5 V). In order to satisfy the $V_{I(RIPPLE)(P-P)}$ specifications, V_{DDP} should be from 4.75V to 5.25V. Due to large transient currents, the 2×100 nF capacitors of the step-up converter should have an ESR of less than 100 m Ω and be located as near as possible to the IC. The supply voltages V_{DD} and V_{DDP} may be applied to the IC in any time sequence. To get the correct deactivation of the card V_{DDP} is allowed to turn-off only when V_{DD} is below the undervoltage threshold. If a voltage between 7 and 9 V is available within the application, this voltage may be tied to pin V_{UB} thus blocking the step-up converter. In this case, V_{DDP} must be tied to V_{DD} and the capacitor between pins S1 and S2 may be omitted.

6.2 Voltage supervisor (for $V_{THSEL} = V_{DD}$ or floating)

This block surveys the V_{DD} supply. A defined reset pulse of approximately 10 ms (t_w) is used internally for maintaining the IC in the inactive mode during powering up or powering down of V_{DD} (see [Figure 3](#)). As long as V_{DD} is less than $V_{th2} + V_{hys(th2)}$, the IC will remain inactive whatever the levels on the command lines. This also lasts for the duration of t_w after V_{DD} has reached a level higher than $V_{th2} + V_{hys(th2)}$. The system controller should not attempt to start an activation sequence during this time. When V_{DD} falls below V_{th2} , a deactivation sequence of the contacts is performed.

6.3 Voltage supervisor (for $V_{THSEL} = GND$)

This block surveys the V_{DD} supply. A defined reset pulse of approximately 10 ms (t_w) is used internally for maintaining the IC in the inactive mode during powering up or powering down of V_{DD} (see [Figure 6](#)). If V_{DD} is less than V_{th3} during a time, longer than ΔT_{HFIL} (max 150 μ s), the IC will remain inactive whatever the levels on the command lines. The IC remain inactive also for the duration of t_w after V_{DD} has reached a level higher than V_{th3} . The system controller should not attempt to start an activation sequence during this time. When V_{DD} falls below V_{th3} during time more than ΔT_{HFIL} , a deactivation sequence of the contacts is performed.

6.4 Clock circuitry

The clock signal (CLK) to the card is either derived from a clock signal input on the pin XTAL1 or from a crystal up to 26 MHz connected between pins XTAL1 and XTAL2.

The frequency may be chosen at f_{XTAL} , $1/2 f_{XTAL}$, $1/4 f_{XTAL}$ or $1/8 f_{XTAL}$ via pins CLKDIV1 and CLKDIV2 (see [Table 18](#)). The frequency change is synchronous, which means that during transition, no pulse is shorter than 45% of the smallest period and that the first and last clock pulse around the change has the correct width.

In the case of f_{XTAL} , the duty factors depend on the signal at XTAL1.

In order to reach a 45% to 55% duty factor on the pin CLK the input signal on XTAL1 should have a duty factor of 48% to 52% and transition times of less than 5% of the input signal period. If a crystal is used with f_{XTAL} , the duty factor on pin CLK may be 45% to 55% depending on the layout and on the crystal characteristics and frequency. In the other cases, it is guaranteed between 45% and 55% of the period. The crystal oscillator runs as soon as the IC is powered-up. If the crystal oscillator is used, or if the clock pulse on XTAL1 is permanent, then the clock pulse will be applied to the card according to the timing diagram of the activation sequence. If the signal applied to XTAL1 is controlled by the microcontroller, then the clock pulse will be applied to the card by the microcontroller after completion of the activation sequence.

Table 18. Clock circuitry

CLKDIV1	CLKDIV2	CLK
0	0	$1/8 f_{XTAL}$
0	1	$1/4 f_{XTAL}$
1	1	$1/2 f_{XTAL}$
1	0	f_{XTAL}

6.5 I/O Circuitry

The three data lines I/O, AUX1 and AUX2 are identical. The Idle state is realized by data lines I/O and I/OUC being pulled HIGH via a 10k resistor (I/O to V_{CC} and I/OUC to V_{DD}). I/O is referenced to V_{CC} , and I/OUC to V_{DD} , thus allowing operation with $V_{CC} \neq V_{DD}$. The first line on which a falling edge occurs becomes the master. An anti-latch circuit disables the detection of falling edges on the other line, which then becomes the slave. After a time delay t_d (edge) (approximately 200 ns), the N transistor on the slave line is turned on, thus transmitting the logic 0 present on the master line. When the master line returns to logic 1, the P transistor on the slave line is turned on during the time delay t_d (edge) and then both lines return to their idle state. This active pull-up feature ensures fast LOW-to-HIGH transitions; it is able to deliver more than 1 mA up to an output voltage of $0.9 V_{CC}$ on a 80pF load. At the end of the active pull-up pulse, the output voltage only depends on the internal pull-up resistor, and on the load current. The maximum frequency on these lines is 1MHz.

6.6 Inactive state

After power-on reset, the circuit enters the inactive state. A minimum number of circuits are active while waiting for the microcontroller to start a session.

- All card contacts are inactive (approximately 200Ω to GND); I/OUC, AUX1UC and AUX2UC are high impedance (10 kΩ pull-up resistor connected to V_{DD})
- Voltage generators are stopped
- XTAL oscillator is running
- Voltage supervisor is active

6.7 Activation sequence

After power-on and, after the internal pulse width delay, the microcontroller may check the presence of the card with the signal $\overline{\text{OFF}}$ ($\overline{\text{OFF}} = \text{HIGH}$ while $\overline{\text{CMDV}}_{\text{CC}}$ is High means that the card is present; $\overline{\text{OFF}} = \text{LOW}$ while $\overline{\text{CMDV}}_{\text{CC}}$ is HIGH means that no card is present). If the card is in the reader (which is the case if $\overline{\text{PRES}}$ or PRES is true), the microcontroller may start a card session by pulling $\overline{\text{CMDV}}_{\text{CC}}$ LOW. The following sequence then occurs (see [Figure 5](#)):

- $\overline{\text{CMDV}}_{\text{CC}}$ is pulled LOW (t₀)
- The voltage doubler is started (t₁~t₀)
- V_{CC} rises from 0 to 5 or 3V with a controlled slope (t₂ = t₁ + 1/23T)(I/O, AUX1 and AUX2 follow V_{CC} with a slight delay); T is 64 times the period of the internal oscillator, approximately 25μs
- I/O, AUX1 and AUX2 are enabled (t₃ = t₁ + 4T)
- CLK is applied to the C3 contact (t₄)
- RST is enabled (t₅ = t₁ + 7T).

The clock may be applied to the card in the following way: set RSTIN High before setting $\overline{\text{CMDV}}_{\text{CC}}$ Low, and reset it Low between t₃ and t₅; CLK will start at this moment. RST will remain LOW until t₅, where RST is enabled to be the copy of RSTIN. After t₅, RSTIN has no further action on CLK. This is to allow a precise count of CLK pulses before toggling RST. If this feature is not needed, then $\overline{\text{CMDV}}_{\text{CC}}$ may be set LOW with RSTIN Low. In this case, CLK will start at t₃, and after t₅, RSTIN may be set High in order to get the Answer To Request (ATR) from the card.

6.8 Active state

When the activation sequence is completed, the ST8004 will be in the active state. Data are exchanged between the card and the microcontroller via the I/O lines. The ST8004 is designed for cards without V_{PP} (this is the voltage required to program or erase the internal non-volatile memory).

Depending on the layout and on the application test conditions (for example with an additional 1pF cross capacitance between C2/C3 and C2/C7) it is possible that C2 is polluted with high frequency noise from C3. In this case, it will be necessary to connect a 220pF capacitor between C2 and CGND.

It is recommended to:

1. Keep track C3 as far as possible from other tracks
2. Have straight connection between CGND and C5 (the 2 capacitors on C1 should be connected to this ground track)
3. Avoid ground loops between CGND, PGND and GND
4. Decoupled V_{DDP} and V_{DD} separately; if the 2 supplies are the same in the application, then they should be connected in star on the main track.

With all these layout precautions, noise should be at an acceptable level, and jitter on C3 should be less than 100ps.

6.9 Deactivation sequence

When a session is completed, the microcontroller sets the $\overline{CMDV_{CC}}$ line to the HIGH state. The circuit then executes an automatic deactivation sequence by counting the sequencer back and ends in the inactive state (see [Figure 6](#)):

- RST goes LOW $\rightarrow(t_{11} = t_{10})$
- CLK is stopped LOW $\rightarrow(t_{12} = t_{11} + \frac{1}{2}T)$ where T is approximately 25 μ s
- I/O, AUX1 and AUX2 are output into high-impedance state $\rightarrow(t_{13} = t_{11} + T)$ (10 k Ω pull-up resistor connected to V_{CC})
- V_{CC} falls to zero $\rightarrow(t_{14} = t_{11} + \frac{1}{2}3T)$; the deactivation sequence is completed when V_{CC} reaches its inactive state
- V_{UP} falls to zero $\rightarrow(t_{15} = t_{11} + 5T)$ and all card contacts become low-impedance to GND;
- I/OUC, AUX1UC and AUX2UC remain pulled up to V_{DD} via a 10 k Ω resistor.

6.10 Fault detection

The following fault conditions are monitored by the circuit:

Short-circuit or high current on V_{CC}

Removing card during transaction

V_{DD} dropping

Overheating.

There are two different cases ([Figure 7](#).)

1. $\overline{CMDV_{CC}}$ HIGH: (outside a card session) then, \overline{OFF} is LOW if the card is not in the reader, and HIGH if the card is in the reader. A supply voltage drop on V_{DD} is detected by the supply supervisor, which generates an internal power-on reset pulse, but does not act upon \overline{OFF} . The card is not powered-up, so no short-circuit or overheating is detected.
2. $\overline{CMDV_{CC}}$ LOW: (within a card session) then, \overline{OFF} falls LOW if the card is extracted, or if a short-circuit has occurred on V_{CC} , or if the temperature on the IC has become too high. As soon as the fault is detected, an emergency deactivation is automatically performed (see [Figure 8](#)). When the system controller sets $\overline{CMDV_{CC}}$ back to HIGH, it may sense \overline{OFF} again in order to distinguish between a hardware problem or a card extraction. If a supply voltage drop on V_{DD} is detected while the card is activated, then an emergency deactivation will be performed and \overline{OFF} goes LOW.

When $\overline{\text{OFF}}$ level falls low, the system controller must wait not less than 160 μs before setting high again the $\overline{\text{CMDV}}_{\text{CC}}$ command.

Depending on the type of card presence switch within the connector (normally closed or normal open), and on the mechanical characteristics of the switch, a bouncing may occur on presence signals at card insertion or withdrawal. There is no debounce feature in the device, so the software has to take it into account; however, the detection of card take off during active phase, which initiates an automatic deactivation sequence is done on the first True/False transition on $\overline{\text{PRES}}$ or PRES , and is memorized until the system controller sets $\overline{\text{CMDV}}_{\text{CC}}$ High. So, the software may take some time waiting for presence switches to be stabilized without causing any delay on the necessary fast and normalized deactivation sequence.

Figure 10. ST8004 Sequencer

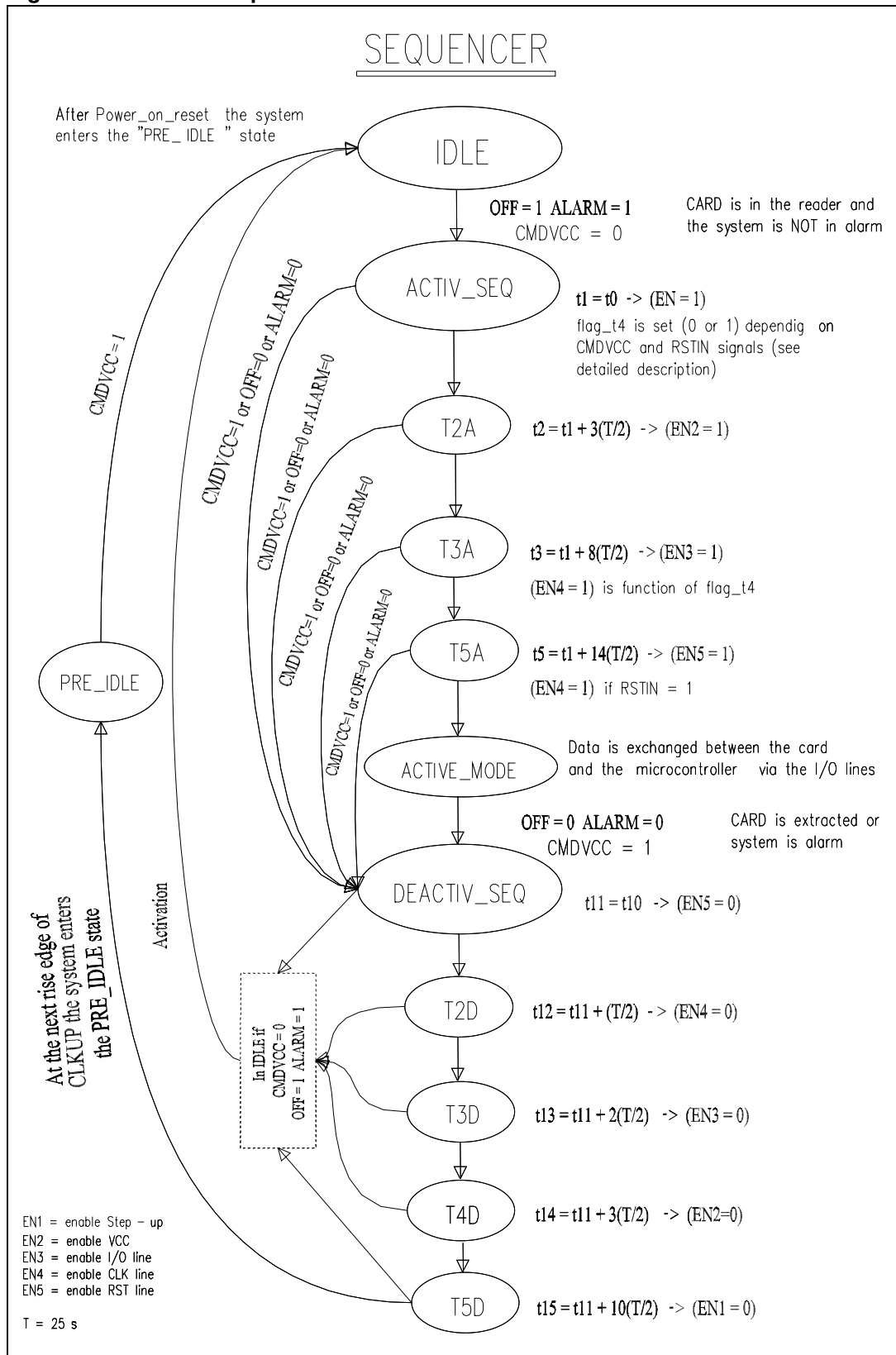
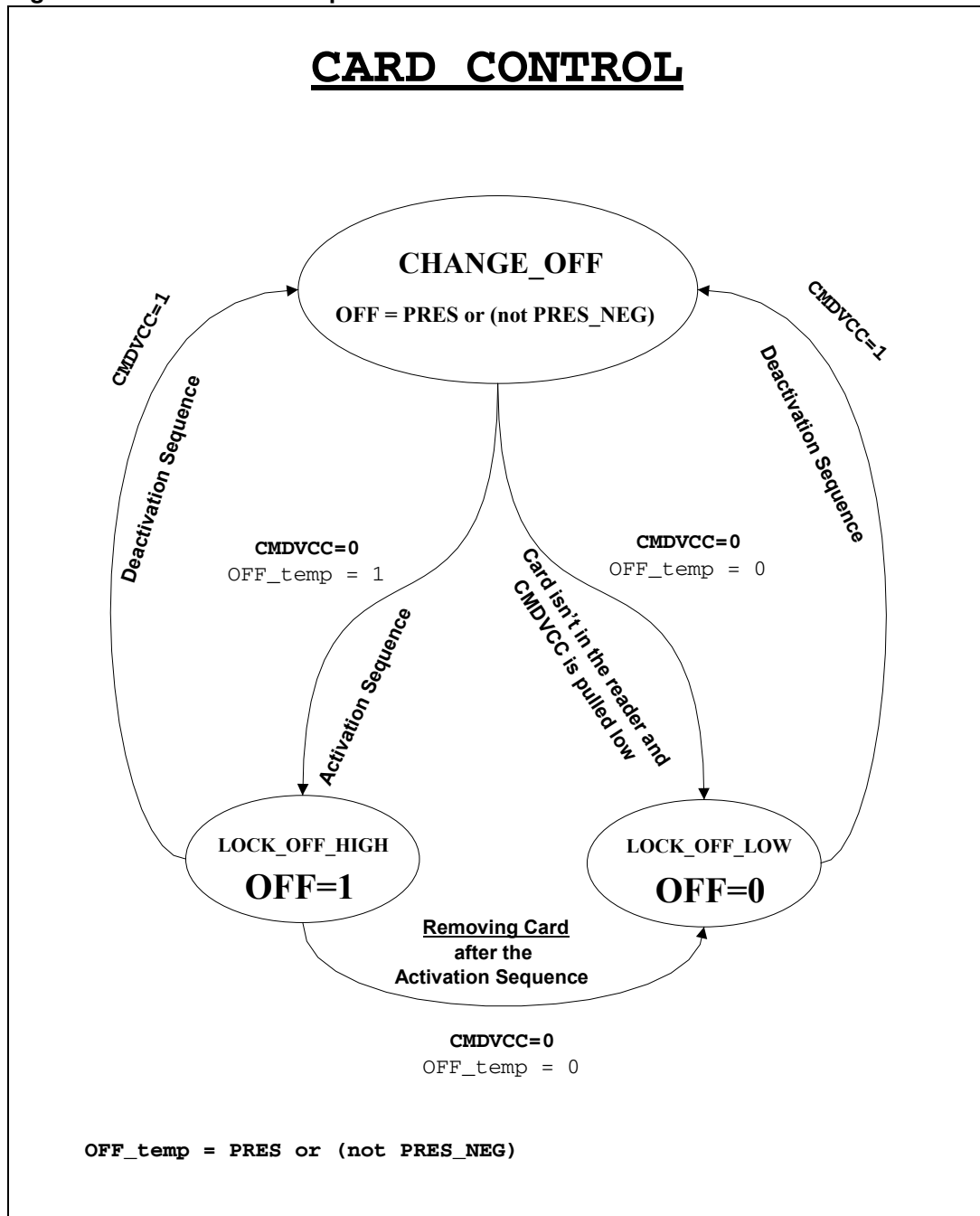

Figure 11. Card control sequencer



7 Package mechanical data

In order to meet environmental requirements, ST offers these devices in ECOPACK® packages. These packages have a Lead-free second level interconnect. The category of second level interconnect is marked on the package and on the inner box label, in compliance with JEDEC Standard JESD97. The maximum ratings related to soldering conditions are also marked on the inner box label. ECOPACK is an ST trademark. ECOPACK specifications are available at: www.st.com

SO-28 MECHANICAL DATA

DIM.	mm.			inch		
	MIN.	TYP	MAX.	MIN.	TYP.	MAX.
A			2.65			0.104
a1	0.1		0.3	0.004		0.012
b	0.35		0.49	0.014		0.019
b1	0.23		0.32	0.009		0.012
C		0.5			0.020	
c1	45° (typ.)					
D	17.70		18.10	0.697		0.713
E	10.00		10.65	0.393		0.419
e		1.27			0.050	
e3		16.51			0.650	
F	7.40		7.60	0.291		0.300
L	0.50		1.27	0.020		0.050
S	8° (max.)					

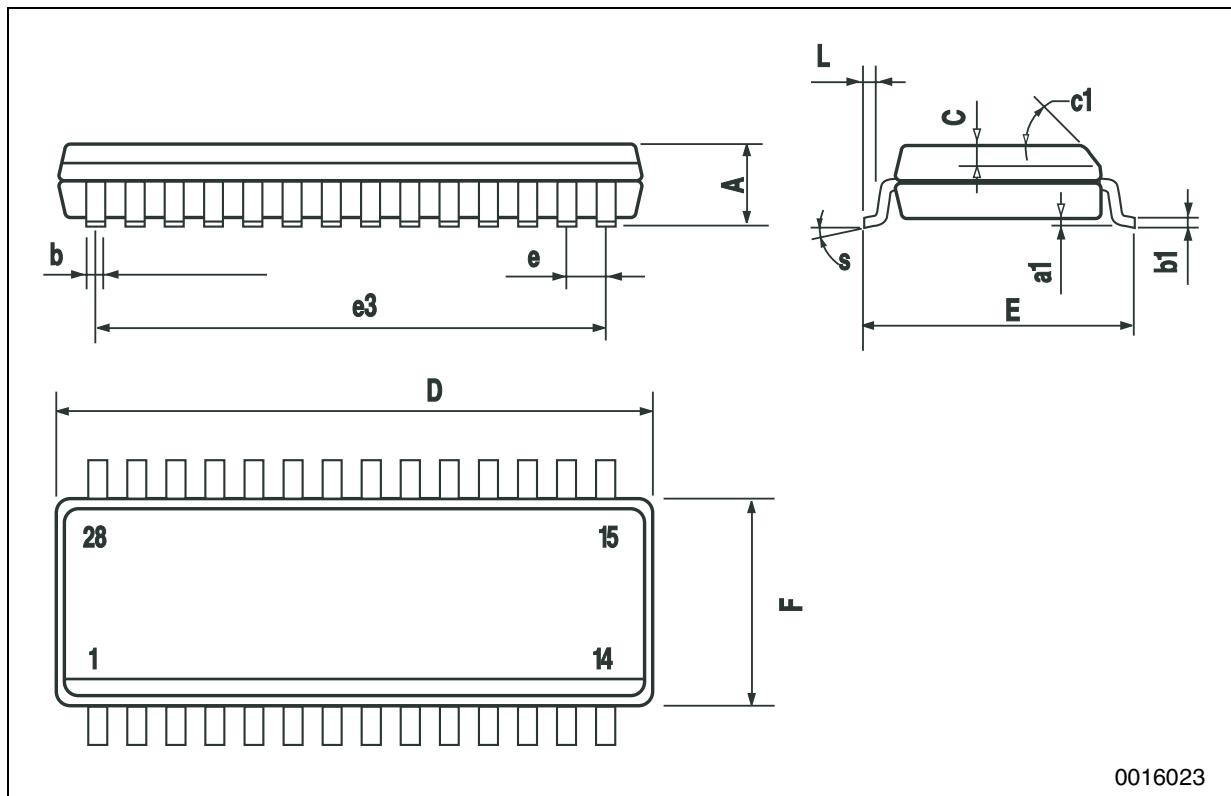

Tape & Reel SO-28 MECHANICAL DATA

DIM.	mm.			inch		
	MIN.	TYP	MAX.	MIN.	TYP.	MAX.
A			330			12.992
C	12.8		13.2	0.504		0.519
D	20.2			0.795		
N	60			2.362		
T			30.4			1.197
Ao	10.8		11.0	0.425		0.433
Bo	18.2		18.4	0.716		0.724
Ko	2.9		3.1	0.114		0.122
Po	3.9		4.1	0.153		0.161
P	11.9		12.1	0.468		0.476

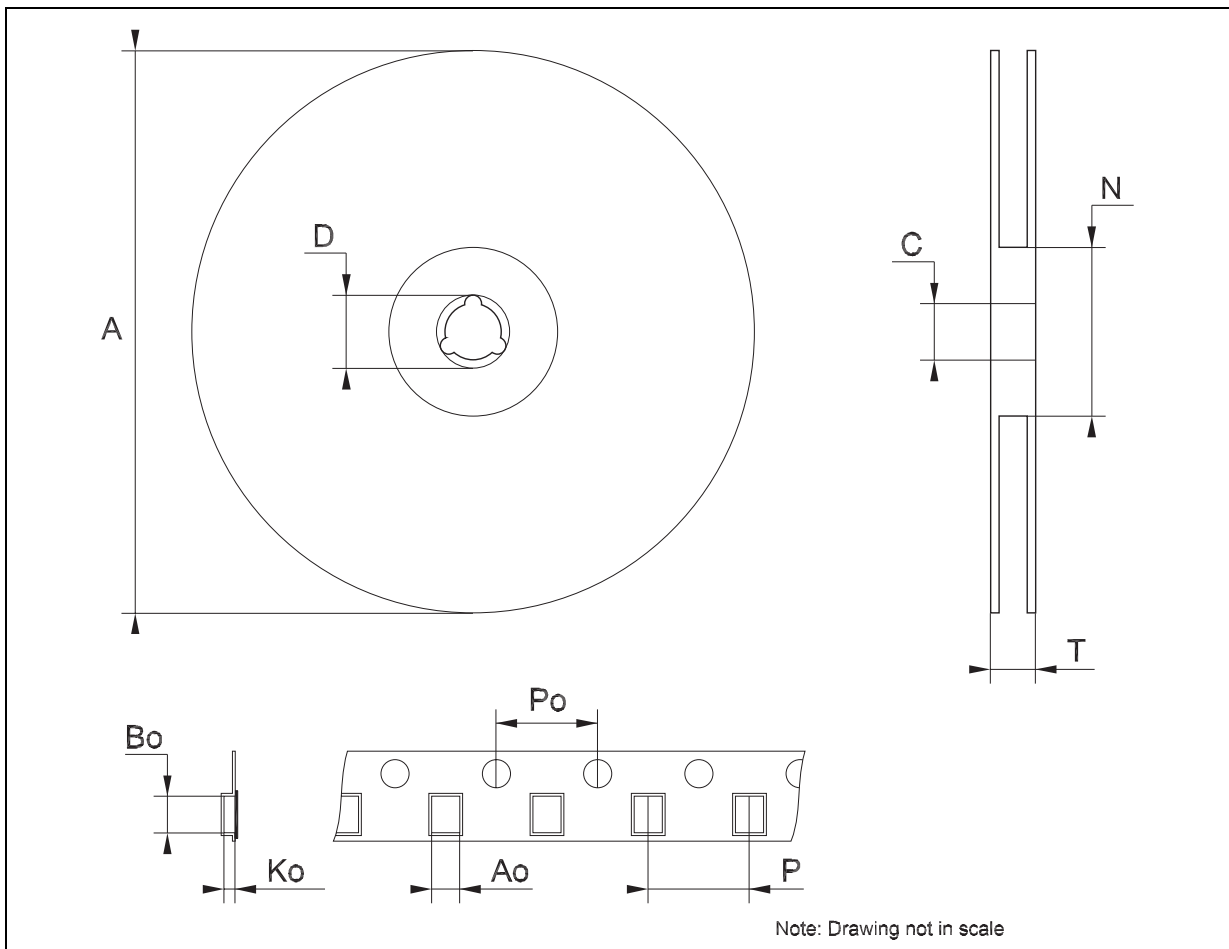

8 Revision history

Table 19. Revision history

Date	Revision	Changes
18-Mar-2004	5	Pag. 10, fig. 4, RSTIN ==> CLK.
04-May-2006	6	Order code has been updated and new template.
31-Jan-2007	7	Change values V_{th3} Min. and Max. on Table 5 .

Please Read Carefully:

Information in this document is provided solely in connection with ST products. STMicroelectronics NV and its subsidiaries ("ST") reserve the right to make changes, corrections, modifications or improvements, to this document, and the products and services described herein at any time, without notice.

All ST products are sold pursuant to ST's terms and conditions of sale.

Purchasers are solely responsible for the choice, selection and use of the ST products and services described herein, and ST assumes no liability whatsoever relating to the choice, selection or use of the ST products and services described herein.

No license, express or implied, by estoppel or otherwise, to any intellectual property rights is granted under this document. If any part of this document refers to any third party products or services it shall not be deemed a license grant by ST for the use of such third party products or services, or any intellectual property contained therein or considered as a warranty covering the use in any manner whatsoever of such third party products or services or any intellectual property contained therein.

UNLESS OTHERWISE SET FORTH IN ST'S TERMS AND CONDITIONS OF SALE ST DISCLAIMS ANY EXPRESS OR IMPLIED WARRANTY WITH RESPECT TO THE USE AND/OR SALE OF ST PRODUCTS INCLUDING WITHOUT LIMITATION IMPLIED WARRANTIES OF MERCHANTABILITY, FITNESS FOR A PARTICULAR PURPOSE (AND THEIR EQUIVALENTS UNDER THE LAWS OF ANY JURISDICTION), OR INFRINGEMENT OF ANY PATENT, COPYRIGHT OR OTHER INTELLECTUAL PROPERTY RIGHT.

UNLESS EXPRESSLY APPROVED IN WRITING BY AN AUTHORIZED REPRESENTATIVE OF ST, ST PRODUCTS ARE NOT DESIGNED, AUTHORIZED OR WARRANTED FOR USE IN MILITARY, AIR CRAFT, SPACE, LIFE SAVING, OR LIFE SUSTAINING APPLICATIONS, NOR IN PRODUCTS OR SYSTEMS, WHERE FAILURE OR MALFUNCTION MAY RESULT IN PERSONAL INJURY, DEATH, OR SEVERE PROPERTY OR ENVIRONMENTAL DAMAGE.

Resale of ST products with provisions different from the statements and/or technical features set forth in this document shall immediately void any warranty granted by ST for the ST product or service described herein and shall not create or extend in any manner whatsoever, any liability of ST.

ST and the ST logo are trademarks or registered trademarks of ST in various countries.

Information in this document supersedes and replaces all information previously supplied.

The ST logo is a registered trademark of STMicroelectronics. All other names are the property of their respective owners.

© 2007 STMicroelectronics - All rights reserved

STMicroelectronics group of companies

Australia - Belgium - Brazil - Canada - China - Czech Republic - Finland - France - Germany - Hong Kong - India - Israel - Italy - Japan - Malaysia - Malta - Morocco - Singapore - Spain - Sweden - Switzerland - United Kingdom - United States of America

www.st.com